



Doors

Solutions for
aluminum profiles

Index

Hinges

- Concealed hinges
- Hinges for profiles with channel
- Hinges for profiles without channel

5

Handles

- Giesse Handles
- Regutti Inox Handles
- Panic exit devices

21

Locks

27

Bolt

31

Seals

33

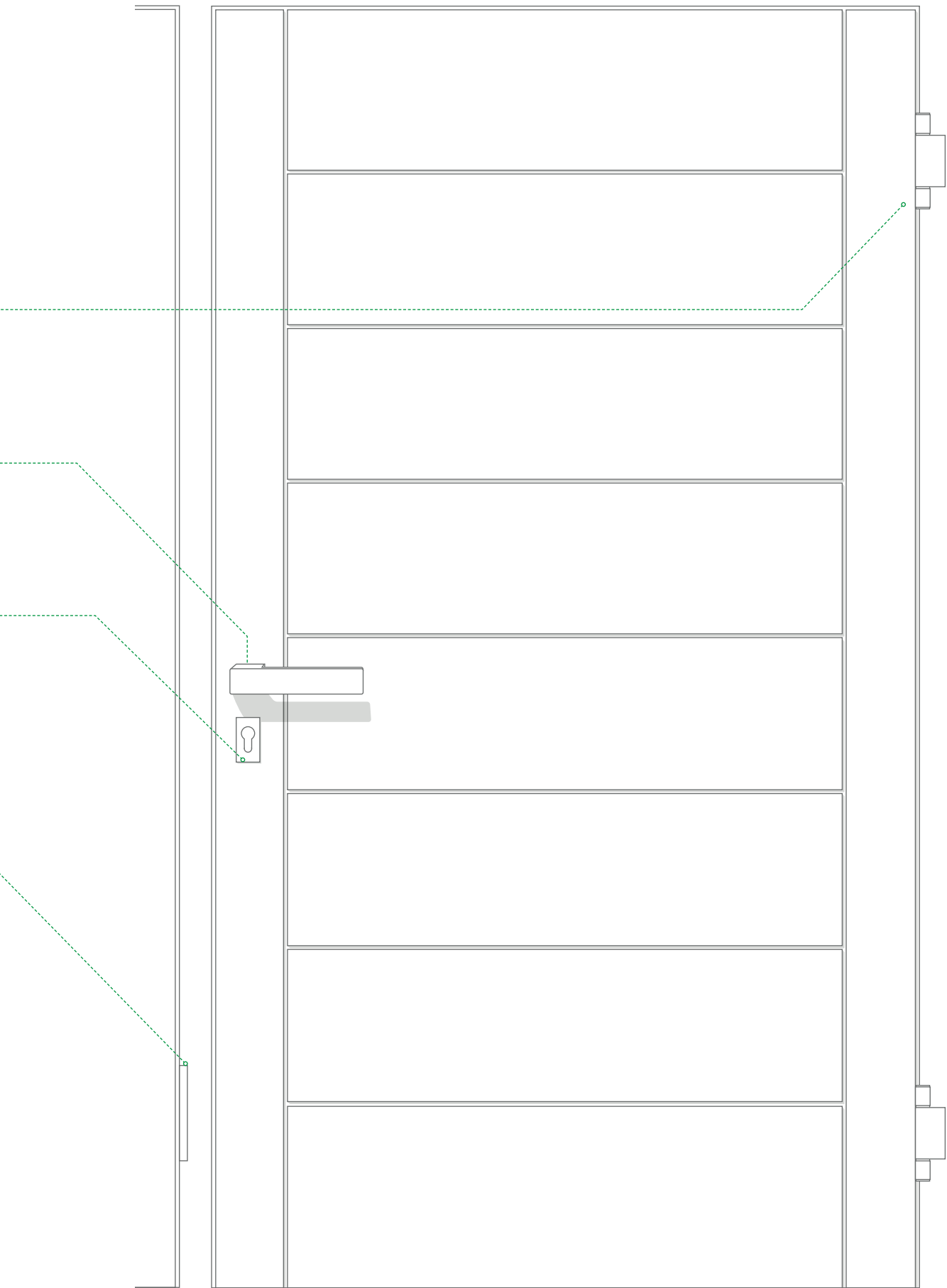

Hinges
Handles
Locks
Bolt
Seals

CHIC DOOR

Concealed hinges

Thanks to their ability to disappear into the frame, CHIC Door hinges give aluminum doors a modern and minimal aesthetic.

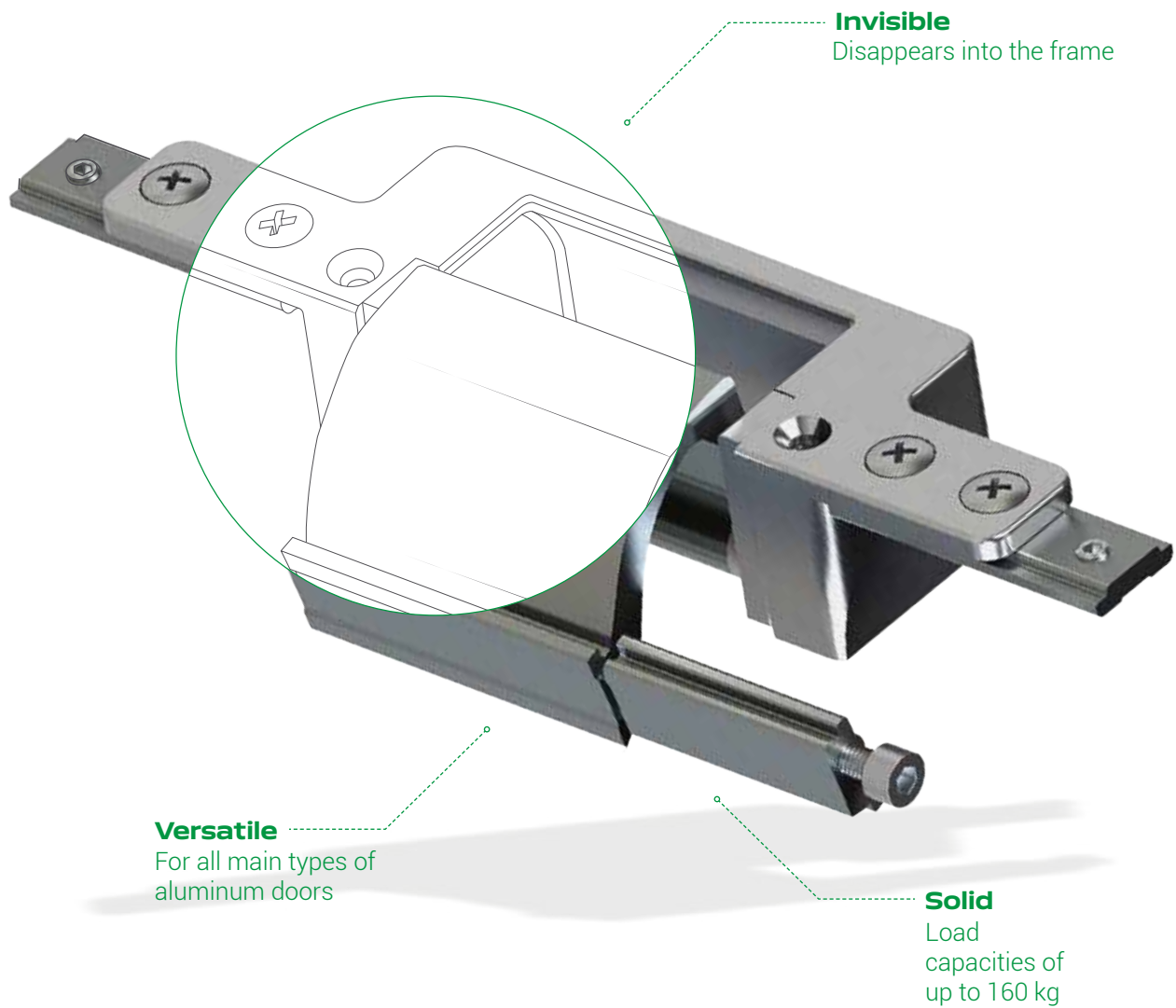

SAFETY

A complete solution for building security

With Giesse hardware, Schlegel seals and Reguitti Handles it is possible to create complete, integrated and safe high-performance windows and doors for all buildings.

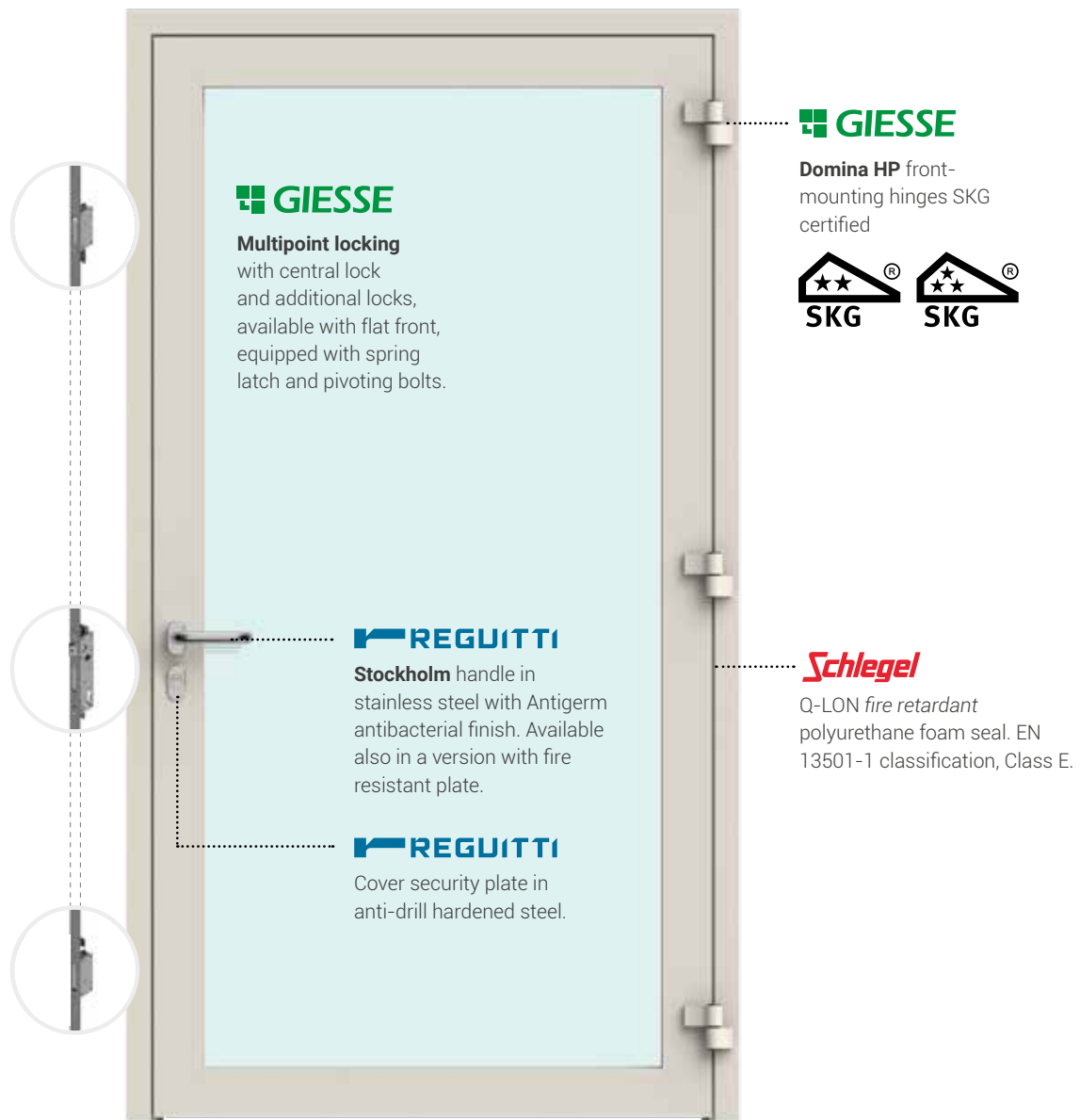

Hinges





	CHIC DOOR EG/RG	CHIC DOOR 160	BRIDGE 2	CELERA
Profiles with channel	✓	×	✓	✓
Concealed	✓	✓	×	×
Load capacity hinges	150 Kg	160 Kg	100 Kg	120 Kg
Height adjustment	-2/+4 mm	-2/+3 mm	×	-
Side adjustment	±2 mm	±3 mm	×	±1 mm
Compression adjustment	-	±1 mm	×	-
Pre-assembled	✓	✓	✓	✓
CE marking	EN 1935	EN 1935	×	EN 1935



	FULCRA	FLASH XXL	DOMINA 2 LEAF	DOMINA 3 LEAF
Profiles with channel	✓	✓	×	×
Concealed	×	×	×	×
Load capacity hinges	150 Kg	180 Kg	180 Kg	200 Kg
Height adjustment	0/+3 mm	-2/+4 mm	0/+4 mm	0/+4 mm
Side adjustment	±2 mm	±1 mm	±2,5 mm	±2,5 mm
Compression adjustment	±0,5 mm	×	±0,5 mm	±0,5 mm
Pre-assembled	✓	✓	✓	✓
CE marking	EN 1935	EN 1935	EN 1935	EN 1935

C.H.I.C. DOOR EG RG For profiles with channel

C.H.I.C. Door is the Giesse range of concealed hinges for Euro Groove and R Groove doors which improves aesthetics, increases the value of the window and simplifies warehouse management.

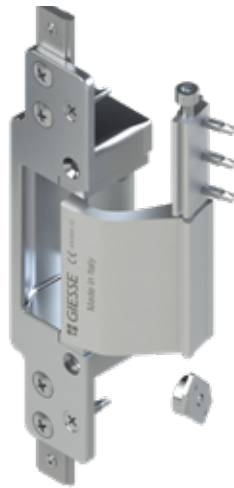

Adjustments

Side = ± 2 mm
Height = -2/+4 mm



Load capacity

x2 = 120 Kg / x3 = 135 Kg / x4 = 150 Kg



Installing

The installation of the door can take place on site in just a few steps.



Opening

Max 105°



Certification

EN1935 (200.000 cycles)



Go to the **CHIC Door EG technical data sheet** for Euro groove



Go to the **technical data sheet CHIC Door RG** for R groove

Code	Description	Series	Limitation arm
00725020	Hinge silver	Euro groove	02030020K
00725190	Hinge black	Euro groove	02030190K
00726020	Hinge silver	R40	02034020K
00726190	Hinge black	R40	02034190K



C.H.I.C. DOOR 160 For profiles without channel

C.H.I.C. Door is the Giesse range of concealed hinges for doors which improves aesthetics, increases the value of the window and simplifies warehouse management.



Adjustments

Side = ± 3 mm / Height = -2/+3 mm
Compression = ± 1 mm



Load capacity

x2 = 160 Kg



Installing

The installation of the door can take place on site in just a few steps.



Opening

Max 105°



Certification

EN1935 (200.000 cycles)



Go to the **technical data sheet**



Code	Description	System
00920020	Hinge silver	Overlap
00920190	Hinge black	Overlap
00917020	Hinge silver	Flush
00917190	Hinge black	Flush
00763	Hinge CTZ	Flush
00757000	Thickness 1 mm*	

* stackable up to a maximum of 3 mm
(for systems with door/frame distance >16mm)

BRIDGE 2

For profiles with channel

Bridge 2 is the hinge for applications that have particular transverse stresses on the axis of the pins.



Load capacity
x2 = 90 Kg / x3 = 100 Kg



Assembly
Fixing is **quick** and **easy** thanks to the pre-assembled components.



Opening
Max 180°



Go to the **technical data sheet**

Code	Description	Series
00600N	Hinge	Euro groove
00601N	Hinge	Euro groove
00602N	Hinge	R40
00603N	Third wing hinge	R40
00604N	Hinge	R50
00605N	Third wing hinge	R50
00606N	Hinge	ALLCO 5S
00607N	Third wing hinge	Gold 400/500/600- Eku 53
00609N	Hinge	Euro groove



CELERA

For profiles with channel

Celera is the new clamp hinge for doors, in which reliability and quick assembly combine perfectly.



Adjustments

Side = ± 1 mm



Load capacity

x2 = 100 Kg / x3 = 120 Kg



Assembly

Quick and **easy** thanks to the pre-assembled fixing plates.



Opening

Max 180°



Certification

EN1935 (200.000 cycles)



Go to the **technical data sheet**



Code	Description	Series
00681	Hinge	Euro groove
00682	Hinge	R40
00684	Outward opening casement hinge (flush)	Euro groove
00685	Hinge	Euro groove frame 14/18 ALU 16 S9
00687	Hinge	R50
00688	Hinge	ALLCO 5S
00689	Hinge	NC40N
00690	Third wing hinge	R40

FULCRA

For profiles with channel

Front mounting clamp hinge, with an innovative patented adjustment system that makes the hinge extremely stable in every position and with perfect alignment of the hinge parts, even at the maximum adjustment ranges.



Adjustments

Side = ± 2 mm / Height = $0/+3$ mm
Compression = $\pm 0,5$ mm



Load capacity

x2 = 120 Kg / x3 = 150 Kg



Assembly

No machining profile, stainless steel fixing plates to be inserted in the channel.



Opening

Max 180°



Certification

EN1935 (200.000 cycles)



Go to the **technical data sheet**

Code	Description	Series
00700	Hinge	Euro groove
00701	Hinge	R40
00702	Hinge for outward opening	Euro groove
00703	Hinge	ALU 16



FLASH XXL

For profiles with channel

Flash XXL is the ideal front mounting clamp hinge for the assembly of doors characterized by large dimensions, heavy weight and intensive use.



Adjustments

Side = ± 1 mm / Height = -2/+4 mm



Load capacity

x2 = 160 Kg / x3 = 180 Kg



Assembly

Semplice e veloce grazie ai componenti pre-assemblati.



Opening

Max 180°



Certification

EN1935 (200.000 cycles)



Go to the **technical data sheet**



Code	Description	Series
00561	Fixing plates	Euro groove
00591	Pre-load fixing plates	Euro groove
00598N	Hinge	Euro groove
00599	Hinge cover	Euro groove

DOMINA For profiles without channel

Domina Classic and Domina Classic are the front-fitting hinge offering high performance and reliability. ideal for use with large, heavy aluminum doors.



Adjustments

Side = $\pm 2,5$ mm / Height = $0/+4$ mm
Compression = $\pm 0,5$ mm



Load capacity

Consultare tabella



Assembly

Semplice e veloce.



Opening

Max 180°



Certification

EN1935 (200.000 cycles)



Go to the **technical data sheet**
Domina HP



Go to the **technical data sheet**
Domina Classic

DOMINA HP hinge have obtained the SKG burglar-proof mark with two-and three-star ratings in accordance with BRL 3104.

SKG TWO STARS Certification

for door configuration with 2 hinges, two or three wings, combined with counterplates or M12 direct screws and anti-burglary balls (*)

THREE STARS SKG Certification

for door configuration with 3 hinges, two or three wings, combined with counterplates or M12 direct screws and anti-burglary balls (*)

To be "burglary-resistant", the hinges must be equipped with the new SKG security kit (page 22) consisting of:

- Anti-cut steel pin that replaces the pin supplied with the hinge (available in the version for 2 wing hinge and 3 wing hinge)
- Stainless steel balls to be inserted into the head of the fixing screws.

(*) expansion dowels for single-unit profiles are not included in the SKG certification

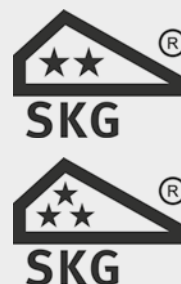

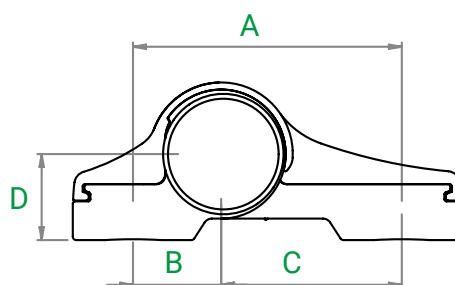

DOMINA HP

Code	Description	Version	C/c distance mm			Lift D	Load capacity hinges		CE
			A	B	C		2	3	
05158V	Domina HP	2 leaf	55,5	13,5	42		120 kg	140 kg	12
05159V	Domina HP	2 leaf	55,5	20,5	42	28	120 kg	140 kg	12
05160V	Domina HP	2 leaf	62,5	20,5	42		160 kg	180 kg	14
05161V	Domina HP	3 leaf	62,5	20,5	42		180 kg	200 kg	14
05162V	Domina HP	2 leaf	70,5	20,5	50		120 kg	140 kg	13
05163V	Domina HP	3 leaf	70,5	20,5	50		140 kg	160 kg	12
05164V	Domina HP	2 leaf	78	20,5	57,5		120 kg	140 kg	13
05165V	Domina HP	3 leaf	78	20,5	57,5		140 kg	160 kg	12
05166V	Domina HP	2 leaf	84	42	42		120 kg	140 kg	13
05167V	Domina HP	3 leaf	84	42	42		140 kg	160 kg	12
05168V	Domina HP	2 leaf	92	42	50		100 kg	120 kg	12
05169V	Domina HP	3 leaf	92	42	50		120 kg	140 kg	12
05170V	Domina HP	2 leaf	99,5	42	57,5		100 kg	120 kg	12
05171V	Domina HP	3 leaf	99,5	42	57,5		120 kg	140 kg	12
05172V	Domina HP	2 leaf	62,5	20,5	42	36	160 kg	180 kg	13
05174V	Domina HP	3 leaf	62,5	20,5	42	27	160 kg	180 kg	13
05175V	Domina HP	2 leaf	62,5	20,5	42	27	180 kg	200 kg	14
05176V	Domina HP	3 leaf	62,5	20,5	42	28	160 kg	180 kg	13
05177V	Domina HP	2 leaf	62,5	20,5	42	28	180 kg	200 kg	14
05178V	Domina HP	3 leaf	62,5	20,5	42	30	160 kg	180 kg	13
05178V	Domina HP	2 leaf	62,5	20,5	42	30	180 kg	200 kg	14

DOMINA CLASSIC

Code	Description	Version	C/c distance mm			Load capacity hinges		CE
			A	B	C	2	3	
06170	Domina Classic	2 leaf	62,5	20,5	42	120 kg	140 kg	13
06171	Domina Classic	3 leaf	62,5	20,5	42	160 kg	180 kg	14
06172	Domina Classic	2 leaf	70,5	20,5	50	100 kg	120 kg	12
06173	Domina Classic	3 leaf	70,5	20,5	50	120 kg	140 kg	13
06174	Domina Classic	2 leaf	78	20,5	57,5	100 kg	120 kg	12
06175	Domina Classic	3 leaf	78	20,5	57,5	120 kg	140 kg	13
06176	Domina Classic	2 leaf	84	42	42	100 kg	120 kg	12
06177	Domina Classic	3 leaf	84	42	42	120 kg	140 kg	13
06178	Domina Classic	2 leaf	92	42	50	80 kg	100 kg	11
06179	Domina Classic	3 leaf	92	42	50	100 kg	120 kg	12
06180	Domina Classic	2 leaf	99,5	42	57,5	80 kg	100 kg	11
06181	Domina Classic	3 leaf	99,5	42	57,5	100 kg	120 kg	12
06168	Domina Classic Industrial	2 leaf	62,5	20,5	42	120 kg	140 kg	13
06169	Domina Classic Industrial	3 leaf	62,5	20,5	42	160 kg	180 kg	14

FIXING SYSTEMS

Domina hinges offer three different fixing systems: counterplates, screws or dowels, based on the profile chosen (see following pages for the configurator).











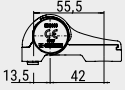

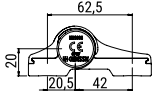

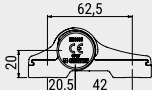

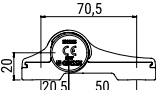

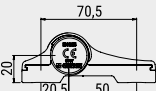

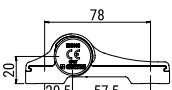

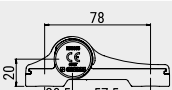

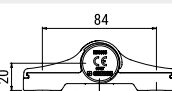
Traditional fixing with counterplates

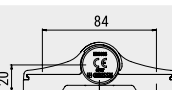
*Quick fixing with M12 screws
(for thermal break profiles)*

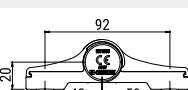
*Quick fixing with expansion dowels
(for single-chamber profiles)*

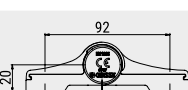

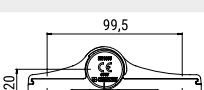
CONFIGURATOR:
DOMINA HP FLUSH

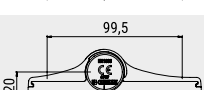
Hinge Code	Version	Drawing	Screws M12 Choose the screw length based on the size of the profile used 05300 = 55 mm 05301 = 65 mm 05302 = 75 mm 05303 = 90 mm	Counterplate Kit	Expansion Dowels 0520401
05158V			-	Included counterplate kit	-
05160V			x4	0520001 (x1)	x4
05161V			x6	0520101 (x1)	x6
05162V			x4	0520001 (x1)	x4
05163V			x6	0520101 (x1)	x6
05164V			x4	0520001 (x1)	x4
05165V			x6	0520101 (x1)	x6
05166V			x4	0520001 (x1)	x4
05167V			x6	0520101 (x1)	x6
05168V			x4	0520001 (x1)	x4
05169V			x6	0520101 (x1)	x6
05170V			x4	0520001 (x1)	x4
05171V			x6	0520101 (x1)	x6











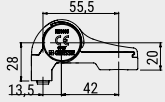

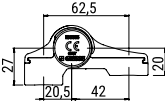

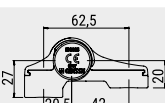
CONFIGURATOR:
DOMINA HP FLUSH WITH STEP

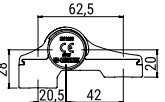
Hinge Code	Version	Drawing	Step	Screws M12	Counter-plate Kit	Expansion Dowels	
				Choose the screw length based on the size of the profile used 05300 = 55 mm 05301 = 65 mm 05302 = 75 mm 05303 = 90 mm		0520401 sash	0520501 frame
05160V			A	x4	-	-	-
			B	-	0520201 (x1)	x2	x2
05161V			A	x6	-	-	-
			B	-	0520301 (x1)	x2	x4
05162V			A	x4	-	-	-
			B	-	0520201 (x1)	x2	x2
05163V			A	x6	-	-	-
			B	-	0520301 (x1)	x2	x4
05164V			A	x4	-	-	-
			B	-	0520201 (x1)	x2	x2
05165V			A	x6	-	-	-
			B	-	0520301 (x1)	x2	x4
05166V			A	x4	-	-	-
			B	-	0520201 (x1)	x2	x2
05167V			A	x6	-	-	-
			B	-	0520301 (x1)	x2	x4
05168V			A	x4	-	-	-
			B	-	0520201 (x1)	x2	x2
05169V			A	x6	-	-	-
			B	-	0520301 (x1)	x2	x4
05170V			A	x4	-	-	-
			B	-	0520201 (x1)	x2	x2
05171V			A	x6	-	-	-
			B	-	0520301 (x1)	x2	x4

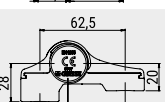
<p>A </p> <ul style="list-style-type: none"> 05095 7 mm 05096 8 mm 05098 9 mm 05097 10 mm 	<p>B </p> <ul style="list-style-type: none"> 05195 7 mm 05196 8 mm 05198 9 mm 05197 10 mm
--	--

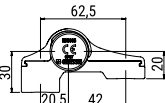

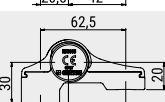
CONFIGURATOR:

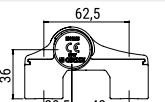
DOMINA HP FLUSH WITH INTEGRATED STEP





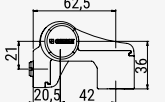

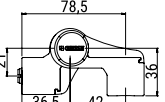



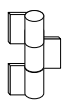
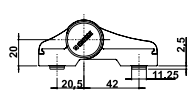

Hinge Code	Version	Drawing	Screws M12 Choose the screw length based on the size of the profile used 05300 = 55 mm 05301 = 65 mm 05302 = 75 mm 05303 = 90 mm	Counter-plate Kit	Expansion Dowels 0520401
05159V				Kit contropiastre incluso	
05174V			x4	0520001 (x1)	x4
05175V			x6	0520101 (x1)	x6
05176V			x4	0520001 (x1)	x4
05177V			x6	0520101 (x1)	x6
05178V			x4	0520001 (x1)	x4
05179V			x6	0520101 (x1)	x6
05172V			x4	0520001 (x1)	x4

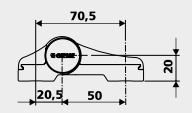
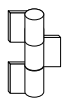
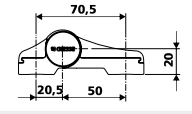
CONFIGURATOR:

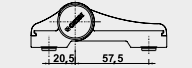
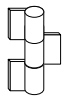
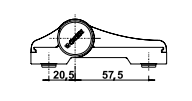
DOMINA HP CORNER

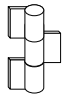
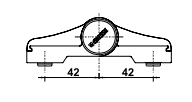
Code	Version	Drawing	Screws M12 Choose the screw length based on the size of the profile used 05300 = 55 mm 05301 = 65 mm 05302 = 75 mm 05303 = 90 mm	Counter-plate	Expansion Dowels 0520401 sash 0520501 frame
05180V			Sash side: Screws M12 (x2) Frame side: 05205N (x2)	0520001 (x1)	x2 x2
05182V			Sash side: Screws M12 (x2) Frame side: 05205N (x2)	0520001 (x1)	x2 x2

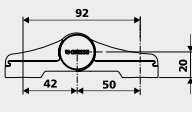
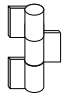
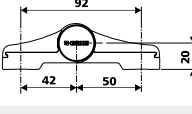
CONFIGURATOR:
DOMINA CLASSIC

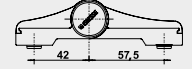
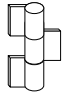
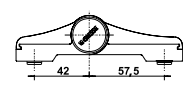
Hinge Code	Version	Drawing	Screws M12 Choose the screw length based on the size of the profile used 05300 = 55 mm 05301 = 65 mm 05302 = 75 mm 05303 = 90 mm	Counter-plate Kit	Expansion Dowels 0520401
06170			x4	0520001 (x1)	x4
06171			x6	0520101 (x1)	x6
06172			x4	0520001 (x1)	x4
06173			x6	0520101 (x1)	x6
06174			x4	0520001 (x1)	x4
06175			x6	0520101 (x1)	x6
06176			x4	0520001 (x1)	x4
06177			x6	0520101 (x1)	x6
06178			x4	0520001 (x1)	x4
06179			x6	0520101 (x1)	x6
06180			x4	0520001 (x1)	x4
06181			x6	0520101 (x1)	x6

DOMINA ACCESSORIES

Code	Description	Version
0520001	Counterplate kit	For Domina 2 wing
0520101	Counterplate kit	For Domina 3 wing
0520201	Counterplate kit	For Domina 2 wing with step
0520301	Counterplate kit	For Domina 3 wing with step
05300	M12 Direct fixing screw	L = 55 mm
05301	M12 Direct fixing screw	L = 65 mm
05302	M12 Direct fixing screw	L = 75 mm
05303	M12 Direct fixing screw	L = 90 mm
0520401	Expansion dowel	Single sealed unit profile for DOMINA flush/one-piece
0520501	Expansion dowel	Single sealed unit profile for DOMINA with step
0323901	Telescopic spacer	Adjustment range 13÷18,5 mm
0324001	Telescopic spacer	Adjustment range 8,5÷29 mm
0324101	Telescopic spacer	Adjustment range 29÷40 mm
0324201	Telescopic spacer	Adjustment range 29÷40 mm
03237	Machining template	For Domina
05052	Machining template	For Domina
03900	Adjuster key	For door hinges
05053	Adjuster key	For Domina HP
05054	Pin extractor	For Domina HP 3 wing

DOMINA SKG COMPONENTS

Code	Description	Screws M12	Compatible Counterplates kit	Spacer
05241	SKG 2 star plugs			
05242	SKG 3 star plugs			
05243	SKG 2-wing burglar-proof kit	052300	0520001	0323901
		052301	0520101	0324001
		052302	0520201	0324101
		052303	0520301	0324201
05244	SKG 2-wing burglar-proof kit	052300	0520001	0323901
		052301	0520101	0324001
		052302	0520201	0324101
		052303	0520301	0324201

Handles



Hinges

Handles

Bolt

Locks

Handles

HANDLES

Handles double for doors

The Giesse double Handles are the ideal solution that combines design and great performance.



Intensive use

Full functionality even in public buildings and hospitals



Assembly

Fixing base with double c/c distance 43 and 50 mm



Base Primer Treatment

It allows you to independently paint the handles in the desired finish



Antigerm

Antibacterial finish available for applications in public buildings such as hospitals and schools



Certification

EN 1906 (200.000 test cycles)



Go to the **technical data sheet**



Code	Description	Square (mm)
02414	Asia	8x8x110
02563	Kora	8x8x110
02422	Master Plus	8x8x110
02792	Prima Plus	8x8x110

HANDLES Reguitti

The range of Reguitti Inox double aluminum door handles includes a wide choice of aesthetics including minimal, square and round.



3W Inox PVD
Gun metal



5M Inox PVD
Lucido oro



5S Satin
stainless steel
304



S5 Satin
stainless steel
316L



KK Matt black
RAL 9005

FINISHES POWDER COATED

CERTIFICATION **EN 1670**

Maximum corrosion resistance according to EN 1670 (**Grade 5**).

CERTIFICATION **ISO 2409**

Maximum resistance of paints to surfaces according to **ISO 2409 (Grade 0)**.

HANDLES Reguitti

The range of Reguitti Inox aluminum door handles includes a vast choice of aesthetics that can be totally customized by section (square, round, rectangular shape and relative size), supports (straight or inclined), length and c/c distance.

5 FINISHES
28 AESTHETICS
484 PRODUCTS

TORONTO 25 **FRANKFURT 30** **LISBONA 30** **DALLAS**

3W Inox PVD
Gun metal

5M Inox PVD
Lucido oro

5S Satin
stainless steel
304

S5 Satin
stainless steel
316L

KK Matt black
RAL 9005

FINISHES POWDER COATED

CERTIFICATION **EN 1670**

Maximum corrosion resistance according to EN 1670 (**Grade 5**).

CERTIFICATION **ISO 2409**

Maximum resistance of paints to surfaces according to **ISO 2409 (Grade 0)**.

PUSH BAR

Panic exit devices

Ease of assembly, durability, compatibility with most profiles, attention to design and highly certified performance, all in one. The wide range allows you to create anti-panic exits for every situation.



Versatile

Modular for many types of single- and double-leaf door configurations.



Reversible

Pre-assembled right-hand. By rotating the bracket you get the left hand.



Fireproof version

Stainless steel strikers guarantee operation even in the event of fire



Security version

With single or multi-point lock, it provides additional security against intrusion.



Certification

UNI EN 1125:2008



Discover all product codes and configurations

Code	Description	EN 1125:2008									
GS AP001	Panic exit device	3	7	7	0	1	4	2	2	A	A
GS AP001 F	Panic exit device modular fire-rated	3	7	7	B	1	4	2	2	A	A
GS AP100	Security panic exit device	3	7	6	0	1	4	2	1	A	B

TOUCH BAR

Panic exit devices

Easy installation, durability, compatibility with most profiles, care in design and highly certified performance all in one. The wide range enables panic exits for every situation.



Versatile

Modular for many types of single- and double-leaf door configurations.



Reversible

Assembly on left or right opening doors does not imply any operation



Fireproof version

Stainless steel strikers guarantee operation even in the event of fire



Certification
UNI EN 1125:2008

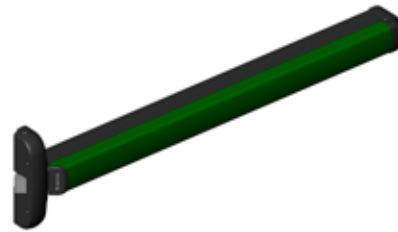

Discover all product codes and configurations

Code	Description	EN 1125:2008									
GS AP002	Panic exit device	3	7	7	0	1	4	2	2	B	A
GS AP002 F	Panic exit device modular fire-rated	3	7	7	B	1	4	2	2	B	A

Locks

Hinges

Handles

Locks

Bolt

Seals



Central lock, slip-on for euro groove profiles, with spring latch and pivoting bolt, equipped with two ways rod adapters

- Square-cylinder c/c distance 85 mm
- Bolt with thickness of 10 mm and minimum protrusion of 24 mm
- Spring latch with 10 to 15 mm adjustable protrusion
- Stroke is 15.5 mm



Full technical datasheet

Lock with central closing

equipped with a burglar-proof tilting bolt and reversible spring latch

- Square-cylinder c/c distance 85 mm
- Bolt with thickness of 10 mm and minimum protrusion of 24 mm
- Spring latch with 10 to 15 mm adjustable protrusion



Full technical datasheet

Equipped Lock with burglar-resistant swinging deadbolt and adjustable roller

- Square-cylinder c/c distance 85 mm
- Bolt with thickness of 10 mm and minimum protrusion of 24 mm
- Protrusion adjustable roller from 4 mm to 13 mm



Full technical datasheet

Lock with shifting bolt and reversible spring latch

- Square-cylinder c/c distance 85 mm
- Single-operated 15 mm shifting bolt with thickness of 10 mm
- 9 to 13 mm adjustable spring latch



Full technical datasheet

Multipoint lock with central lock and additional locks, flat front plate geometry , equipped with spring latch and pivoting bolts.

- Cylinder handle C/C distance 85 mm
- Bolts with thickness of 10 mm and minimum protrusion of 24 mm
- Spring latch with 10 mm protrusion



Full technical datasheet



Multipoint lock with central lock and additional locks. "U" shaped front geometry. Equipped with burglar-proof pivoting bolts and a reversible spring latch.

- Cylinder handle C/C distance 85 mm
- Bolts with thickness of 10 mm and minimum protrusion of 24 mm
- Spring latch with 10 mm protrusion



Full technical datasheet



Perimeter locks compatible with European profile cylinders, available in version with or without bolt. Coupled with the polyamide rod, via the specific connection adapters, the lock enables multipoint closure by appropriately choosing the number and position of the locking points on the various sides of the door.



Full technical datasheet



The Giesse Locks match the Giesse counterplates and cylinders



Discover **the cylinders**



Discover **the counterplates**

Locks

Code	Description	Backset	Front width	C/C distance
0462701	Lock for top/bottom fastening	30 mm	22 mm	85 mm
0462801	Lock for top/bottom fastening	35 mm	22 mm	85 mm
0461301	Central lock with spring latch	25 mm	22 mm	85 mm
0461401	Central lock with spring latch	30 mm	22 mm	85 mm
0461501	Central lock with spring latch	35 mm	22 mm	85 mm
0461901	Central lock with spring latch	25 mm	24 mm	85 mm
0462001	Central lock with spring latch	30 mm	24 mm	85 mm
0462101	Central lock with spring latch	35 mm	24 mm	85 mm
04616	Central lock with spring roller	25 mm	22 mm	85 mm
04617	Central lock with spring roller	30 mm	22 mm	85 mm
04618	Central lock with spring roller	35 mm	22 mm	85 mm
04623	Central lock with spring roller	30 mm	24 mm	85 mm
04624	Central lock with spring roller	35 mm	24 mm	85 mm
0763001	Central lock with front closing	25 mm	22 mm	85 mm
0763101	Central lock with front closing	30 mm	22 mm	85 mm
0763201	Central lock with front closing	35 mm	22 mm	85 mm
04854	Multipoint lock flat front	30 mm	24 mm	85 mm
04855	Multipoint lock flat front	35 mm	24 mm	85 mm
04850	Multipoint lock U front	25 mm	24 mm	85 mm
04851	Multipoint lock U front	30 mm	24 mm	85 mm
04852	Multipoint lock U front	35 mm	24 mm	85 mm
04645	Lock for perimeter fastening without bolt	35 mm	22 mm	85 mm
04646	Lock for perimeter fastening with bolt	35 mm	22 mm	85 mm
04649	Lock for perimeter fastening without bolt	45 mm	22 mm	85 mm
04650	Lock for perimeter fastening with bolt	45 mm	22 mm	85 mm
04698	Lock for perimeter fastening without bolt	45 mm	22 mm	92 mm
04699	Lock for perimeter fastening with bolt	45 mm	22 mm	92 mm
04659	Balcony door lock with bolt	35 mm	22 mm	85 mm

Bolt



Hinges

Handles

Locks

Bolt

Seals



	TOTEM	MAYA	PESOS	BULL
Bolt tip stroke	21	21	18	40
Resistance to burglary	✓	✓	✓	✓
Reversible	✓	✗	✓	✓
Extendable	✓	✗	✓	✗
Customisable finish	✗	✓	✓	✓
Version with key	✗	✗	✗	✓

Bolt

Code	Description	Bolt tip
02080	Maya Bolt 140 mm	8x5 mm
02081	Maya Bolt 220 mm	8x5 mm
02082	Maya Bolt 450 mm	8x5 mm
02083	Maya Bolt 650 mm	8x5 mm
02170	Totem Bolt	8x7 mm
02185	Totem Bolt	8x7 mm
02150	Pesos Bolt	∅ 6/8 mm
02151	Pesos front cover	-
02158	Security terminal for Pesos	∅ 8 mm
02340	Pesos guide for rod	-
02180	Bull bolt without key	∅ 10 mm
02181	Bull bolt with key	∅ 10 mm

Floor striker plates

Code	Description
01320	Rod striker plate for sill (stainless steel)
01326	Rod striker plate for sill
02182	Bull bolt striker plate
02144	Threshold bush with shutter
02159	Threshold bush
02183	Threshold bush Bull bolt
03901	Door stop

Seals



Hinges

Handles

Locks

Bolt

Seals

Q-LON polyurethane foam weatherseals

The exclusive Q-LON seal is made from a special polyurethane foam contained in a weather resistant polyethylene film.

- Excellent recovery after compression, even at low temperatures
- The lowest thermal conductivity on the market (0.04 W/m·K at 0 °C)
- Low compression force required
- The outer film is not altered by paints, detergents and colourants
- High resistance to weather and UV rays
- Exceptional sound insulation performance
- Wide range of colours
- Fire retardant version available



Full technical datasheet

Brush pile seals

Seals made from virgin polypropylene (PP) yarn.

- Seals made from virgin polypropylene (PP) yarn.
- Different densities depending on the seal type, width and assembly distance
- Thermosetting for recovery after compression
- Central and side fins for maximum airtightness
- Excellent resistance to abrasion and static build-up
- UV stable and chemically inert for extended longevity
- Silicone-treated PP yarn to resist water, soil and mould



Full technical datasheet

Extruded seals

Seals made in a range of extruded materials can be combined with foam seals.

- Very wide range of colours available
- Three different densities and materials for optimal performance
- Configurable geometries from the simplest to the most specific shapes



Full technical datasheet





Schlegel

High performance sealing solutions



GIESSE

Innovative engineered hardware



REGUITTI

Italian design handles



DATEC

Timeless exclusive handles

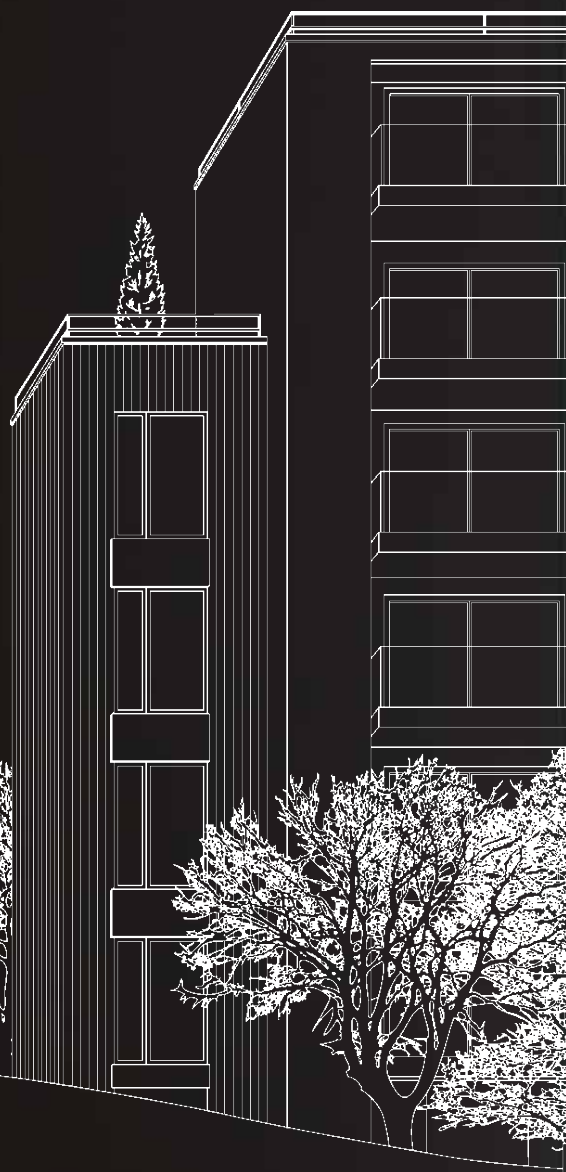

TYMAN
International

GIESSE S.p.A. Via Tubertini 1, 40054 Budrio (BO), Italia
Tel: +39 051 8850000 | email: info.it@tyman.com



U1089001
04/2024